

DO NOT INSULATION TEST WITH SPOTLIGHTS INSTALLED ON THIS TRACK!

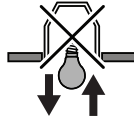

230-240V~ 50/60Hz

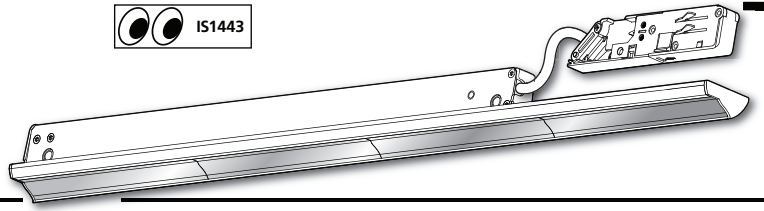

1 ⚡ 230-240V + DALI
Tide LH

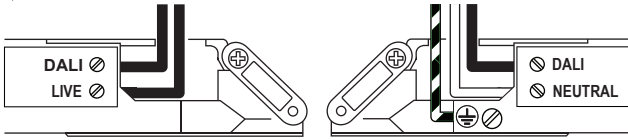

1 ⚡ 230-240V + DALI
Tide RH

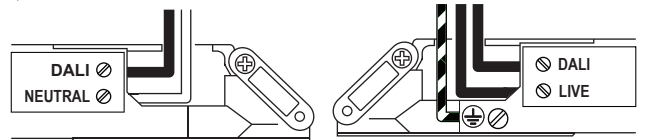

2

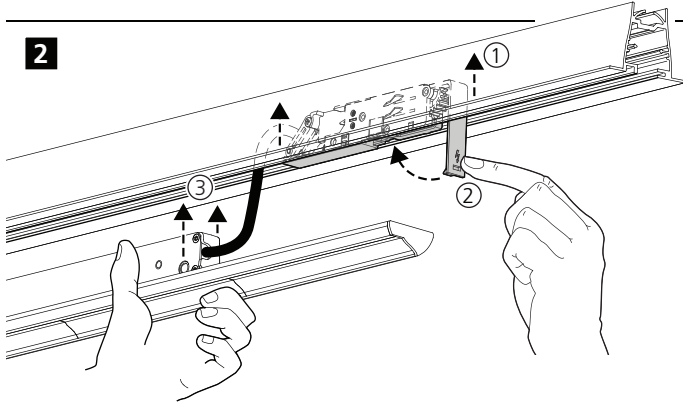

3

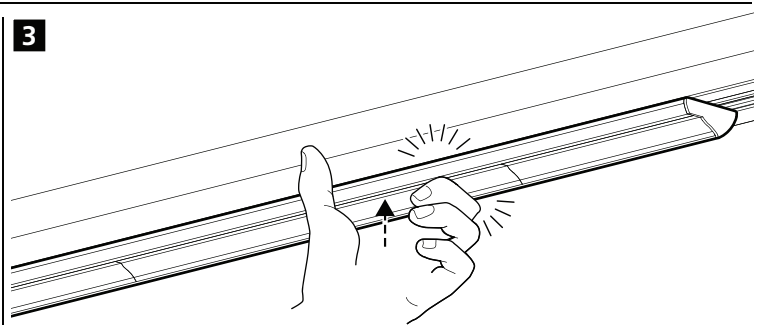

DALI Push-Up Live Feed



? DALI Push-Up Live Feeds
LH

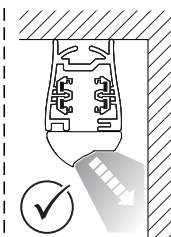
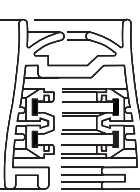

? DALI Push-Up Live Feeds
RH

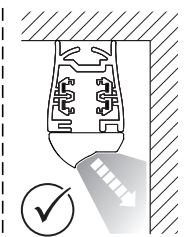
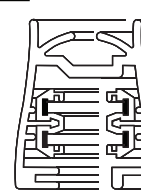

1 ⚡ 230-240V + DALI

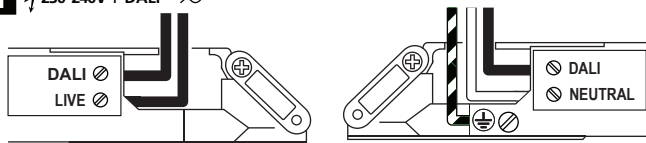

1 ⚡ 230-240V + DALI

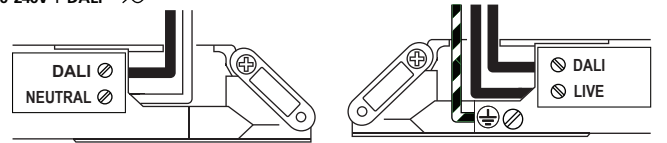

2

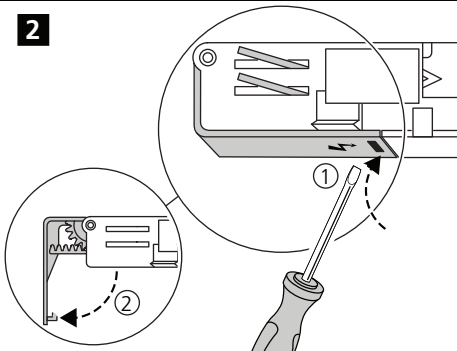

3

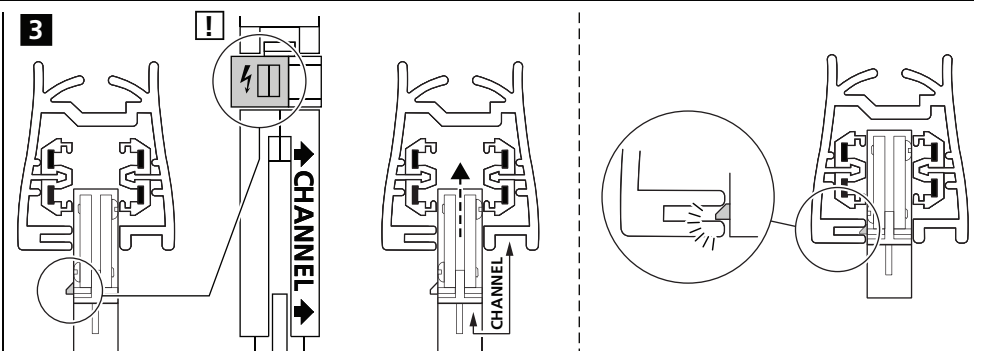

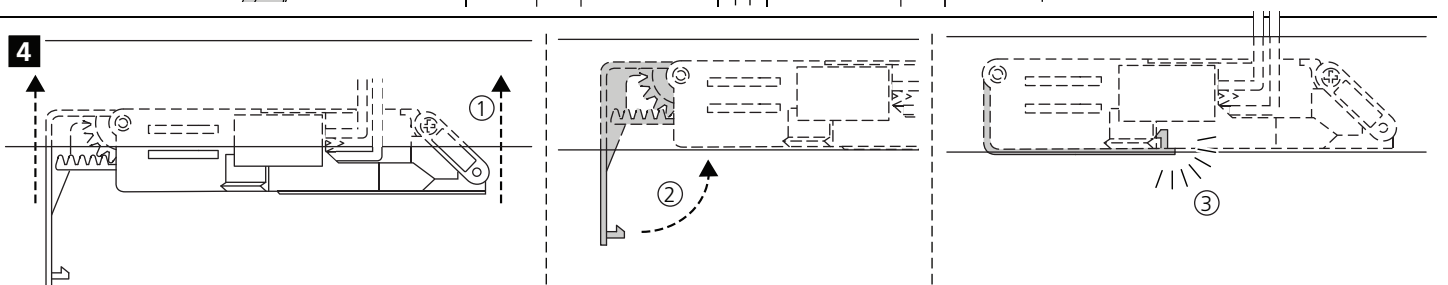

4



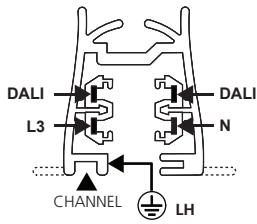

Live End  IS573

? Live End  LH



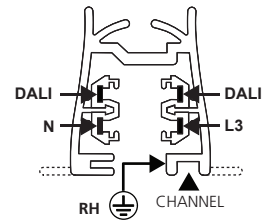

? Live End  RH



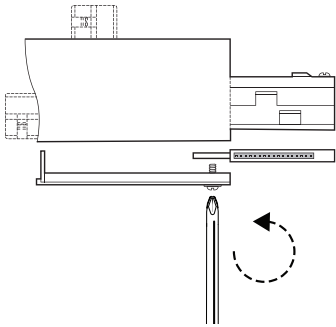

1  2 x PG15

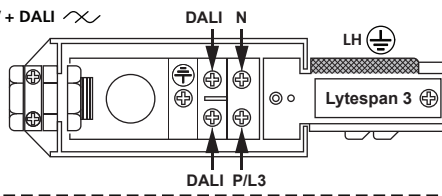

2  230-240V + DALI 

 LH



2  230-240V + DALI 

 RH

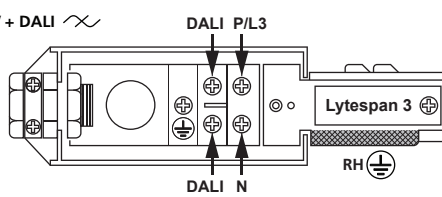

3

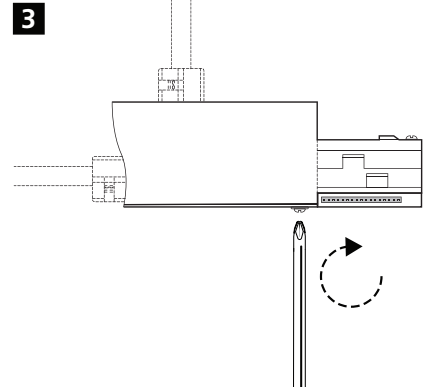

4  LH

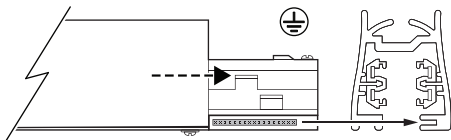

5 

 LH

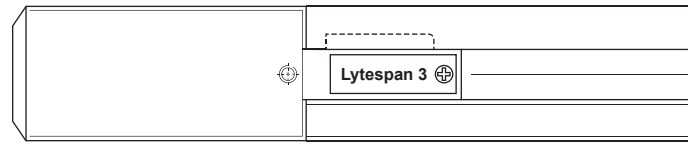

4  RH

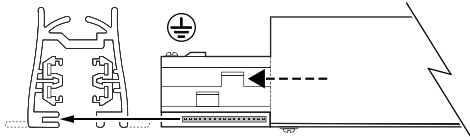

5 

 RH

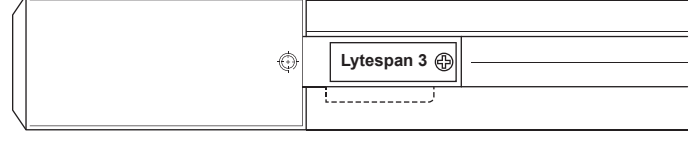

1 

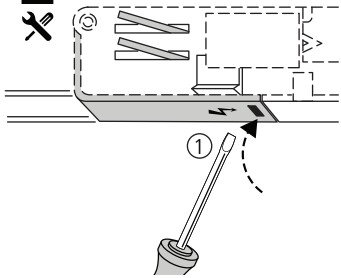

2 

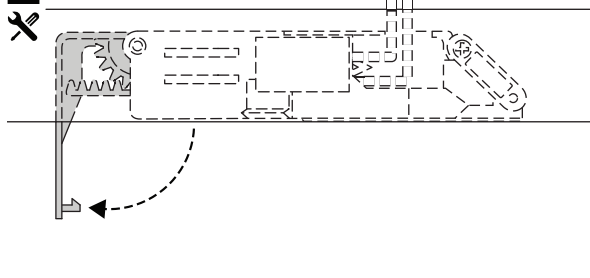

3 

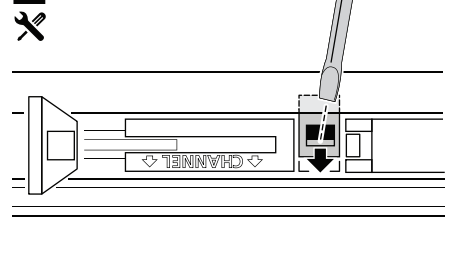

4 

